

MODEL: T-1275 with Master Vent
VOLTAGE: 12
DIMENSIONS: Inches (mm)
BATTERY: Flooded/wet lead-acid battery
COLOR: Maroon (case/cover)
MATERIAL: Polypropylene
WATERING SYSTEM: HydroLink™ Watering System



T2 Technology™

PRODUCT SPECIFICATIONS

BCI GROUP SIZE	TYPE	CAPACITY ^A Minutes			CAPACITY ^B Amp-Hours (AH)				ENERGY (kWh)	TERMINAL Type ^E	DIMENSIONS ^C Inches (mm)			WEIGHT lbs. (kg)
		@25 Amps	@56 Amps	@75 Amps	5-Hr Rate	10-Hr Rate	20-Hr Rate	100-Hr Rate			100-Hr Rate	Length	Width	
12 VOLT DEEP CYCLE BATTERY - with T2 TECHNOLOGY™														
N/A	T-1275	280	102	70	120	134	150	166	1.99	1, 2	12.96 (329)	7.13 (181)	11.13 (283)	82 (37)

A. The number of minutes a battery can deliver when discharged at a constant rate at 80°F (27°C) and maintain a voltage above 1.75 V/cell. Capacities are based on peak performance.
B. The amount of amp-hours (AH) a battery can deliver when discharged at a constant rate at 80°F (27°C) and 86°F (30°C) for the 5-Hour rate and maintain a voltage above 1.75 V/cell. Capacities are based on peak performance.

C. Dimensions are based on nominal size. Dimensions may vary depending on type of handle or terminal.
D. Dimensions taken from bottom of the battery to the highest point on the battery. Heights may vary depending on type of terminal.
E. Terminal images are representative only.
 Trojan's Battery testing procedures adhere to both BCI and IEC test standards.

CHARGING INSTRUCTIONS



CHARGER VOLTAGE SETTINGS (AT 77°F/25°C)				
System Voltage	12V	24V	36V	48V
Daily Charge	14.8	29.6	44.4	59.2
Float	13.2	26.4	39.6	52.8
Equalize	15.5	31.0	46.5	62.0

Do not install or charge batteries in a sealed or non-ventilated compartment. Constant under or overcharging will damage the battery and shorten its life as with any battery.

CHARGING TEMPERATURE COMPENSATION

028 VPC for every 10°F (5.55°C) above or below 77°F (25°C)
add .028 VPC for every 10°F (5.55°C) below 77°F and subtract .028 VPC for every 10°C above 77°F

TERMINAL CONFIGURATIONS

1	ELPT	Embedded Low Profile Terminal	
	Terminal Height Inches (mm)	1.22 (31)	
	Torque Values in-lb (Nm)	95-105 (11 - 12)	
	Bolt Size	5/16"	
2	EHPT	Embedded High Profile Terminal	
	Terminal Height Inches (mm)	1.50 (38)	
	Torque Values in-lb (Nm)	95-105 (11 - 12)	
	Bolt Size	5/16"	

OPERATIONAL DATA

Operating Temperature	Self Discharge
-4°F to 113°F (-20°C to +45°C). At temperatures below 32°F (0°C) maintain a state of charge greater than 60%.	5 - 15% per month depending on storage temperature conditions.

BATTERY DIMENSIONS (shown with EHPT)

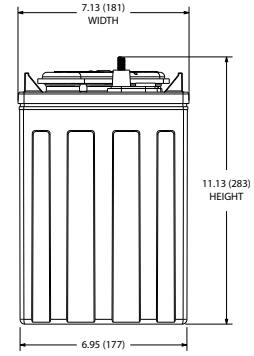
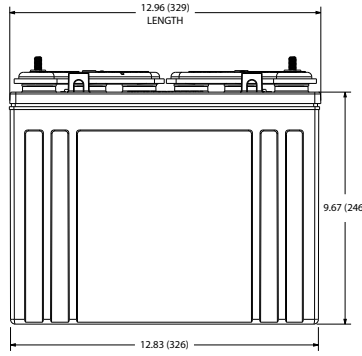
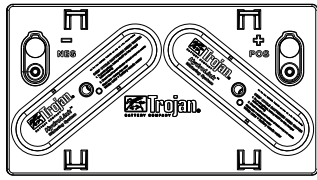

TROJAN T-1275 PERFORMANCE

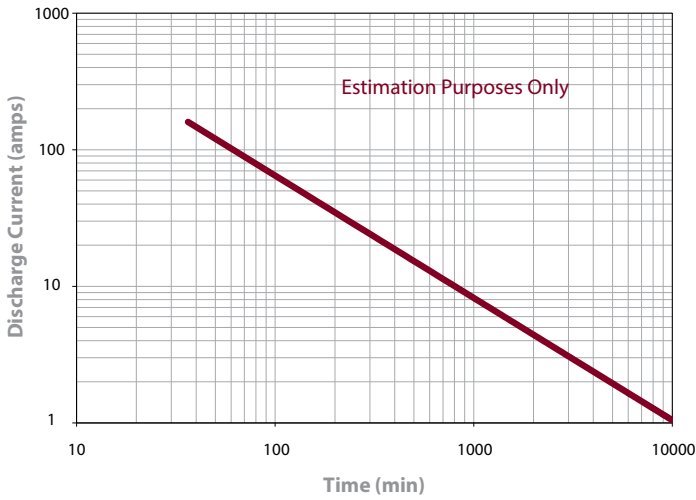

PERCENT CAPACITY VS. TEMPERATURE

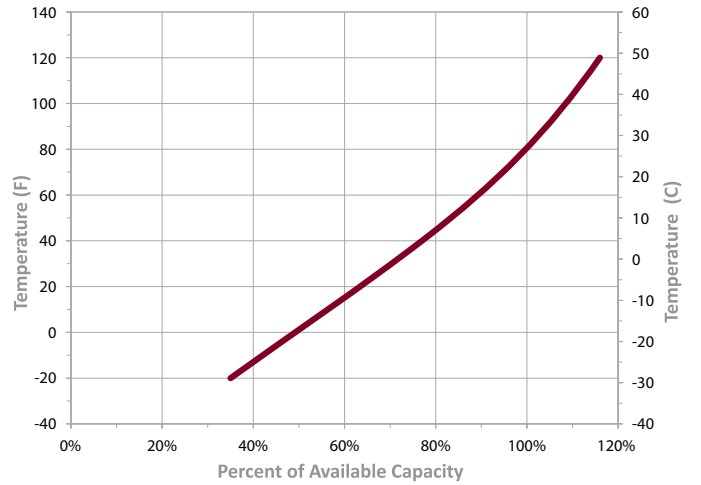

TYPICAL CYCLE LIFE IN A STATIONARY APPLICATION

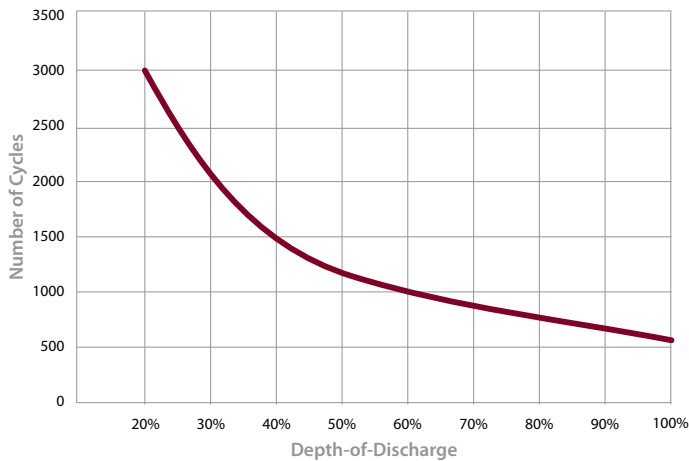

Trojan batteries are available worldwide through Trojan's Master Distributor Network. We offer outstanding technical support, provided by full-time application engineers.

trojanbattery.com

800.423.6569 or + 1.562.236.3000
12380 Clark Street, Santa Fe Springs, CA 90670 • USA